

(1) FLYWHEEL PULLER
(2) FLYWHEEL

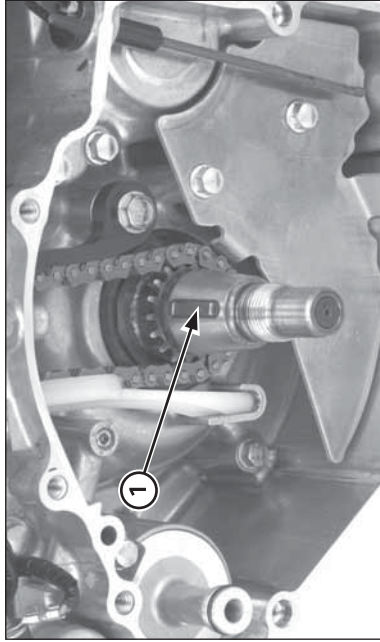

(1) WOODRUFF KEY

Remove the flywheel using the special tool.

Tool:
Flywheel puller (Generic tool)

Remove the woodruff key.

Installation

Install the woodruff key onto the crankshaft groove.

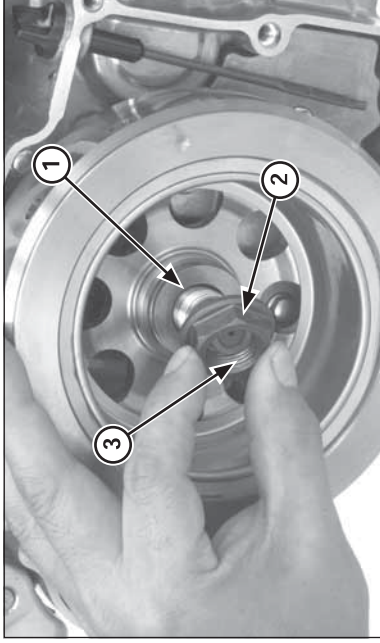

(1) WASHER
(2) FLYWHEEL NUT
(3) APPLY OIL

Install the flywheel onto the crankshaft.
Apply oil to the flywheel nut threads and seating surface.
Install the washer and flywheel nut.



Hold the flywheel with flywheel holder, tighten the flywheel nut to the specified torque.

Tool:
Flywheel holder 89020-NN4-003

Torque: 167 N•m (17.0 kgf•m, 123 lbf•ft)

Install the left crankcase cover (page 3-50).