

Blown Fuse

Before handling fuses, see "Inspecting and Replacing Fuses." ► P. 42

Fuse Box Fuses

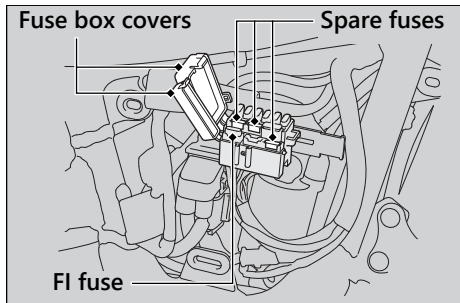

1. Remove the right side cover. ► P. 52
2. Open the fuse box cover.
3. Pull the fuses out one by one to check for a blown fuse. Always replace a blown fuse with a spare fuse of the same rating.
4. Close the fuse box cover.
5. Reinstall the right side cover.