

Tool Kit

The tool kit (1) is stored in the tool kit compartment (2) under the seat.

After using the tools, be sure to use the rubber band (3) to fasten the tool kit securely.

To access the tool kit, remove the seat (see page 110), and then remove the rubber band.

An optional, larger tool kit may be available. Check with your dealer's parts department.

UNDER SEAT

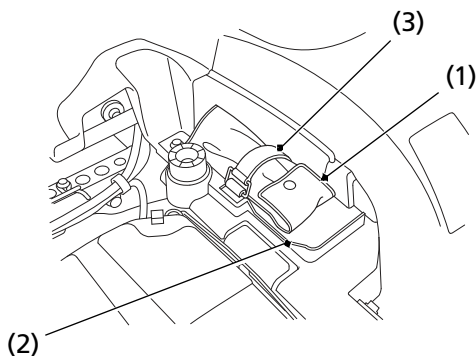

- (1) tool kit
- (2) tool kit compartment
- (3) rubber band