

Controls & Features

To apply the parking brake:

Bring the vehicle to a complete stop, then make sure the transmission is in neutral.

Squeeze the rear brake lever /parking brake lever (1), then rotate the P/R lever (2) clockwise until it engages the slot on the rear brake lever/parking brake lever bracket.

For more information on *Parking*, see page 104.

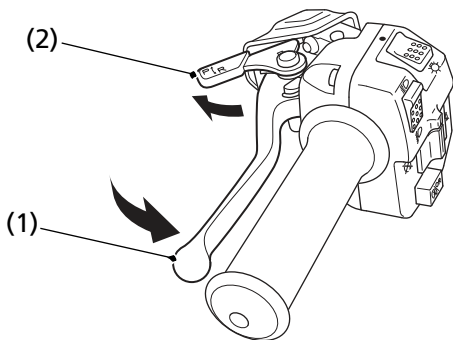

(1) rear brake lever/parking brake lever

(2) P/R lever

To release the parking brake:

Squeeze the rear brake lever/parking brake lever until the P/R lever is released from the slot on the rear brake lever/parking brake lever bracket.

The brake light is activated by applying the parking brake. When using the parking brake, be sure to turn the ignition switch to OFF (w) to avoid discharging the battery.

To shift the transmission into reverse:

See *Riding in Reverse*, page 87.