

Drivetrain Boots

Front Driveshaft Boots

Refer to *Safety Precautions* on page 113.

FRONT

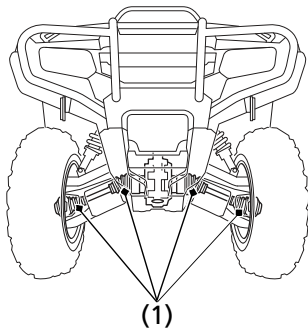

(1) driveshaft boots

Check the driveshaft boots (1) for cuts, damage or leaking grease. If necessary, have your dealer replace them.