

Seat Removal

Refer to *Safety Precautions* on page 111.

The seat must be removed for the engine oil filter, air cleaner, spark plug, battery and fuse maintenance and to remove the rear fender cover and tank cover assembly, to access the owner's manual, air pressure gauge, gear change tool and tool kit.

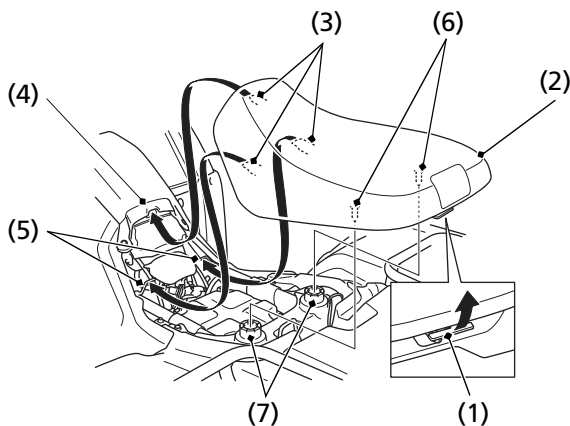

(1) seat latch

(2) seat

(3) front prongs

(4) tank cover

(5) hooks

(6) studs

(7) grommets

Removal

1. Pull the seat latch (1) at the rear of the seat.
2. Slide the seat (2) back and lift it.

Installation

1. Insert the front prongs (3) into the backside of the tank cover (4) and hooks (5) on the frame, and press the studs (6) into the grommets (7).
2. Press down on the seat until locks.