

Suspension

Rear Suspension Adjustment (SXS1000M3/M3P only)

Using a pin spanner, which is available from your dealer, the rear suspension can be adjusted for carrying heavier cargo.

Do not attempt to disassemble, service, or dispose of the damper; see your dealer. The instructions found in this owner's manual are limited to adjustments of the shock assembly only.

Rear Suspension Spring Pre-Load (SXS1000M3/M3P only)

Refer to *Safety Precautions* on page 123.

REAR

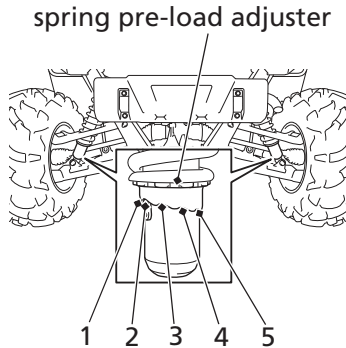

The spring pre-load adjuster has 5 positions for different load or riding conditions. Before adjusting the spring pre-load, jack up your Honda SXS (page 144) to avoid damaging the adjusters.

Use the pin spanner to adjust the shock spring pre-load.
Pin spanner part number: 07702-0020001
Available through your dealer.