

Fuel

Fuel Capacity

Fuel tank capacity:
7.9 US gal (30 ℓ)

When there is only one segment left in the fuel gauge (page 24), fuel will be low and you should refuel as soon as possible.

Refueling Procedure

Refer to *Safety Precautions* on page 111.

RIGHT SIDE

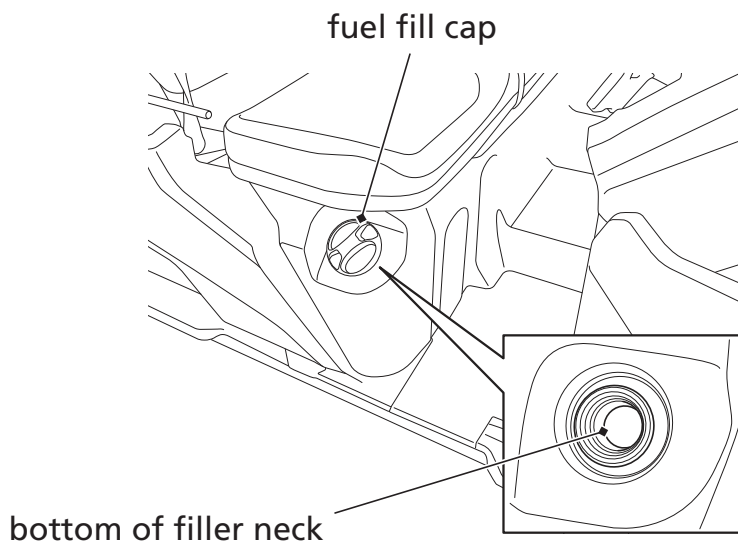

1. Open the right side door (page 45).
2. Turn the fuel fill cap counterclockwise.
3. Add fuel until the level reaches the bottom of the filler neck.
Avoid over filling the tank. There should be no fuel in the filler neck.