

Cylinder Head Cover Installation

1. Check that the spark plug hole packing (1) is in good condition and replace it if necessary. Apply engine oil to the spark plug hole packing and install it to the cylinder head cover (2).
2. Check that the cylinder head cover packing (3) is in good condition and replace it if necessary. Clean and apply liquid sealant (TB1207B or equivalent) to the cylinder head cover groove (4) in the shown and install the cylinder head cover packing into the cylinder head cover groove.

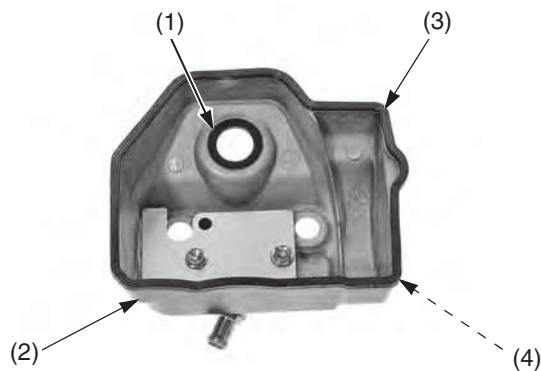

- (1) spark plug hole packing
- (2) cylinder head cover
- (3) cylinder head cover packing
- (4) cylinder head cover groove

3. Check that the rubber seals (5) are in good condition, replace them if necessary. Install the rubber seals onto the cylinder head cover with the "UP" marks (6) facing up.

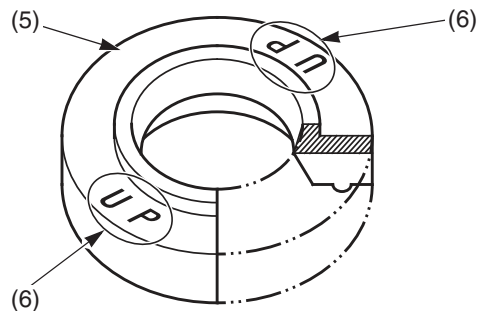

- (5) rubber seals
- (6) "UP" marks

4. Install the cylinder head cover (2) and tighten the cylinder head cover socket bolts (7) to the specified torque:
7 lbf·ft (10 N·m, 1.0 kgf·m)

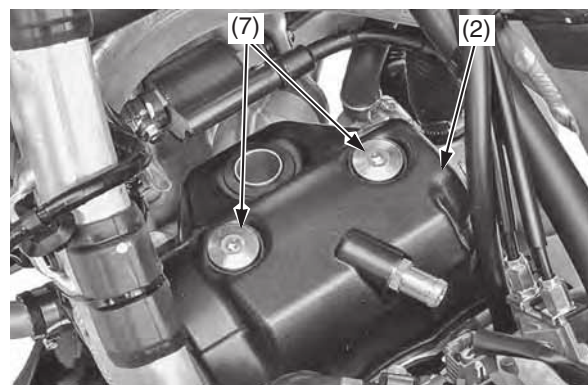

- (2) cylinder head cover
- (7) cylinder head cover socket bolts

5. Connect the spark plug cap (8) and breather tube (9).

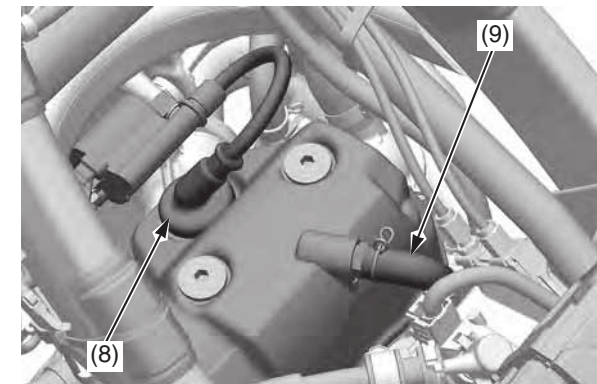

- (8) spark plug cap
- (9) breather tube

6. Install the fuel tank and seat (pages 43, 47).