

Clutch System

Other Inspections

- Check that the clutch lever assembly is positioned properly (the end of the holder (1) is aligned with the paint mark (2) on the handlebar) and the securing bolts are tight.

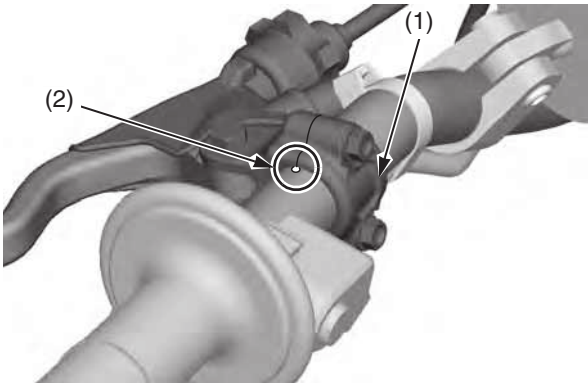

(1) holder
(2) paint mark

- Check the clutch cable for kinks or signs of wear. If necessary, have it replaced.

Clutch Operation

1. Check for smooth clutch lever operation. If necessary, lubricate the clutch lever pivot bolt sliding surface with grease and/or clutch cable with commercially available cable lubricant.
2. Check the clutch cable for deterioration, kinks, or damage.

Clutch Cable Lubrication

Check for smooth clutch lever operation. If necessary, apply multi-purpose grease to sliding surface of the clutch cable ends.

1. Release the dust cover (1).
2. Turn the adjuster (2) and remove the clutch cable (3).
3. Disconnect the clutch cable end from the clutch lever (4).
4. Thoroughly lubricate the clutch cable end (5) with multi-purpose grease.

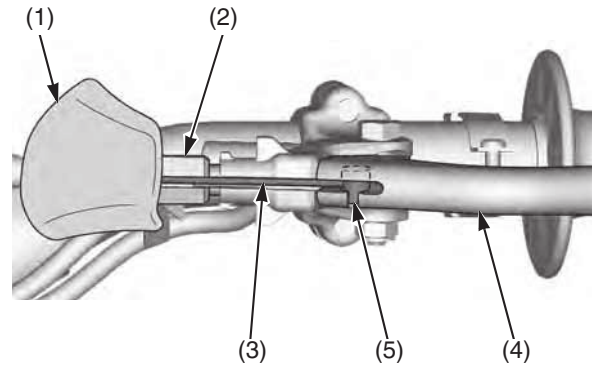

(1) dust cover
(2) adjuster
(3) clutch cable
(4) clutch lever
(5) clutch cable end

5. Connect the clutch cable end to the lever.
6. Install the clutch cable and turn the adjuster.

7. Remove the clutch cable end adjuster (6).
8. Apply multi-purpose grease to the clutch cable end adjuster inside surface.

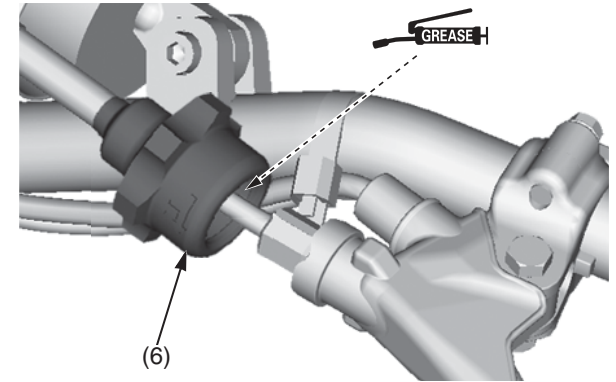

(6) clutch cable end adjuster

9. Recheck clutch lever freeplay and adjust as necessary (page 75).

If the clutch lever operation is not smooth, replace the clutch cable.