

Wheels

RIGHT REAR

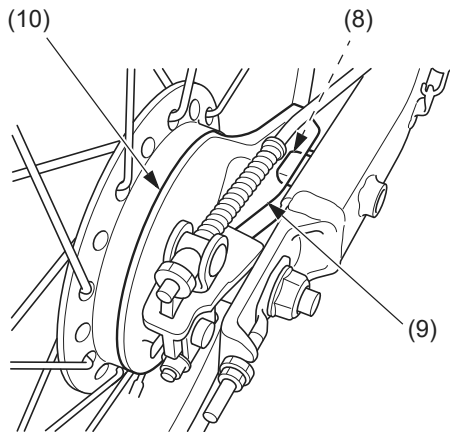

- (8) lug
- (9) slot
- (10) brake panel

Installation

1. Reverse the removal procedure. Make sure the lug (8) on the swingarm is located in the slot (9) in the brake panel (10). Check that the chain adjusters are installed properly.
2. Adjust the drive chain (page 107).
3. Torque the rear axle nut to:
46 lbf·ft (62 N·m , 6.3 kgf·m)
4. Adjust the rear brake (page 90).
5. Apply the rear brake, release it, then spin the wheel and check that it rotates freely. Repeat this procedure several times.

If a torque wrench was not used to install the wheel, see your dealer as soon as possible to verify proper assembly. Improper assembly may lead to loss of braking capacity.