

Fuel

Refueling Procedure

Fuel Tank Capacity, including reserve:
0.79 US gal (3.0 ℓ , 0.66 Imp gal)

Reserve Capacity:
0.24 US gal (0.9 ℓ , 0.20 Imp gal)

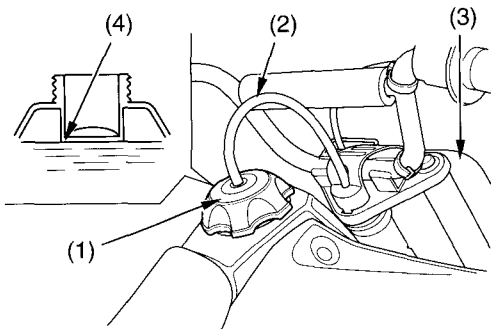

(1) fuel fill cap
(2) breather tube

(3) front number plate
(4) filler neck

1. To open the fuel fill cap (1), pull the breather tube (2) away from the front number plate (3). Turn the fuel fill cap counterclockwise and remove it.
2. Add fuel until the level reaches the bottom of the filler neck (4). Avoid overfilling the tank. There should be no fuel in the filler neck.

⚠ WARNING

Gasoline is highly flammable and explosive. You can be burned or seriously injured when handling fuel.

- Stop the engine and keep heat, sparks and flame away.
- Handle fuel only outdoors.
- Wipe up spills immediately.