

Drive Chain

2. Check drive chain slack at several points along the chain. The slack should remain constant. If it isn't, some links may be kinked and binding. Lubricating the chain will often eliminate binding and kinking.

NOTICE

Excessive chain slack may allow the drive chain to damage the engine cases.

3. Inspect the drive chain for:
 - damaged rollers
 - loose pins
 - dry or rusted links
 - kinked or binding links
 - excessive wear

Replace the drive chain (page 104) if it has damaged rollers, loose pins, or kinks that cannot be freed. Lubricate the drive chain (page 103) if it appears dry or shows signs of rust. Lubricate any kinked or binding

links and work them free. Adjust chain slack if needed.

4. Check the chain slider (2) for wear. If the ridge (3) in the center of the slider is worn, have your Honda dealer replace the chain slider.

LEFT SIDE

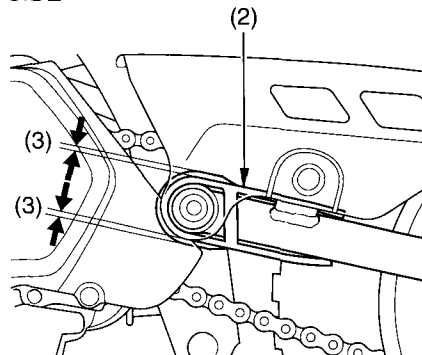

(2) chain slider

(3) ridge