

## BULB REPLACEMENT

(Refer to the maintenance precautions on page 62).

### Headlight/Position Light Bulb

#### ▲WARNING

- \* The light bulb becomes very hot while the light is ON, and remain hot for a while after it is turned OFF. Be sure to let it cool down before servicing.

#### CAUTION:

- \* Wear clean gloves while replacing the bulb.
- \* Do not put finger prints on the headlight bulb, as they may create hot spots on the bulb and cause it to break.
- \* If you touch the bulb with your bare hands, clean it with a cloth moistened with alcohol to prevent its early failure.

#### NOTE:

- \* Be sure to turn the ignition switch OFF when replacing the bulb.

1. Remove the clips (1) from the lid (2).
2. Remove the lid from the fairing stay (3).  
Being careful not to damage the retaining tabs of the lid (2).

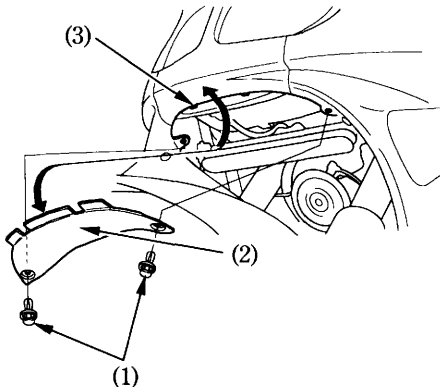

- (1) Clips  
(2) Lid

- (3) Fairing stay