



Throttle

Throttle Freeplay

Refer to *Safety Precautions* on page 99.

RIGHT HANDLEBAR

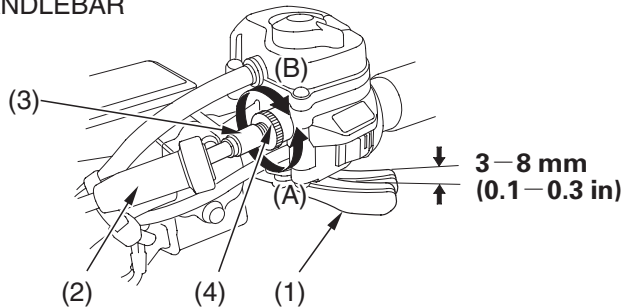

- | | |
|-----------------------------|-----------------------|
| (1) throttle lever | (4) lock nut |
| (2) rubber sleeve | (A) decrease freeplay |
| (3) throttle cable adjuster | (B) increase freeplay |

Inspection

Check freeplay at the throttle lever (1).

Freeplay:

3–8 mm (0.1–0.3 in)

Adjustment

1. Slide the rubber sleeve (2) back to expose the throttle cable adjuster (3).
2. Loosen the lock nut (4).
3. Turn the adjuster to obtain the correct freeplay.
4. Tighten the lock nut and reinstall the sleeve.
5. After adjustment, check for smooth operation of the throttle lever from fully closed to fully open in all steering positions.

