

Engine Stop Switch

The engine stop switch (Fig. 2-6) is next to the left handgrip, and it has three positions. When the switch is in the RUN (○) position, the engine will operate. When the switch is in either OFF (⊗) position, the engine will not operate.

This switch is intended primarily as a safety or emergency control, and it should normally remain in the RUN (○) position.

NOTE:

If you stop your FOURTRAX by turning the engine stop switch OFF (⊗), be sure to turn the ignition switch OFF (○) to prevent battery discharge.

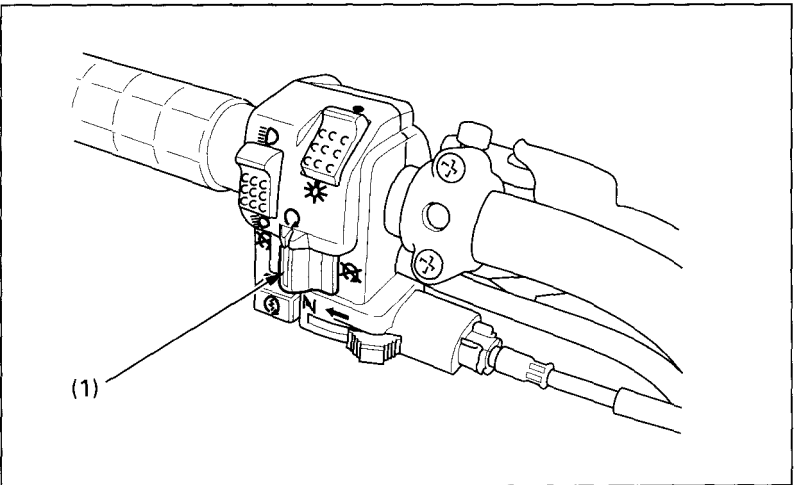

Fig. 2-6

(1) Engine stop switch