

FUEL SYSTEM

FUEL

Refueling

The fuel tank capacity, including reserve, is:

3.17 US gal (12.0 ℓ , 2.64 Imp gal)

The reserve fuel supply is:

0.71 US gal (2.7 ℓ , 0.59 Imp gal)

To open the fuel fill cap (1), pull out the breather tube (2) from the handle cover hole (3). Then turn the fuel fill cap counterclockwise.

Do not overfill (make sure there is no fuel in the filler neck (4)).

After refueling, be sure to tighten the fuel fill cap firmly by turning it clockwise until it clicks.

Insert the breather tube into the handle cover hole.

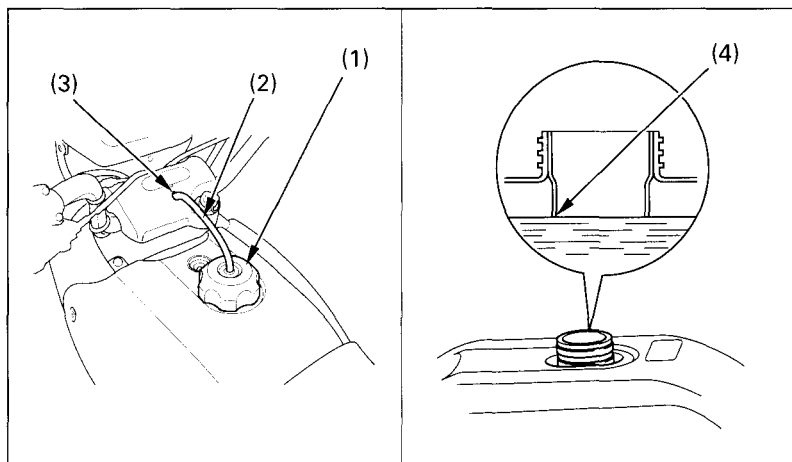

Fig. 4-2 (1) Fuel fill cap
(2) Breather tube
(3) Handlebar cover hole

(4) Filler neck