

To check rear brake shoe wear:

When the brake is applied, an arrow (3) attached to the brake arm (2) moves toward a reference mark (4) on the brake panel (see Fig. 4-30).

If the arrow aligns with the reference mark on full application of the brake, the brake shoes must be replaced. See your authorized Honda dealer for this service.

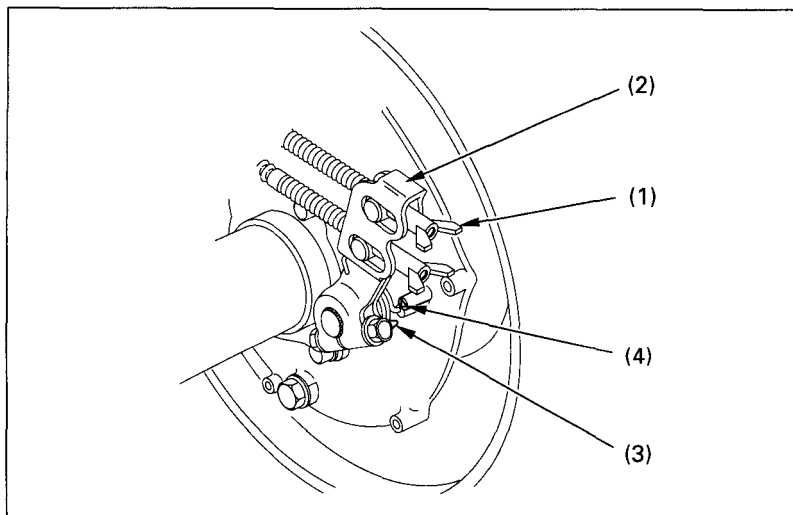

Fig. 4-30 (1) Brake lever adjusting nut (3) Arrow
 (2) Brake arm (4) Reference mark

Other Checks:

Check the condition of the brake cables. If there are kinks or signs of wear that could cause sticking or failure, have the cables replaced by an authorized Honda dealer. Make sure the brake arm, spring, and fasteners are in good condition.