

## LIGHTS

### Headlight and Dimmer Switches

The headlight and dimmer switches (Fig.2-13) are above the starter button, next to the gearshift switches.

Turning the headlight switch (1) ON (☼) turns the headlight and assist headlight on. Use the dimmer switch (2) to select either high beam HI (≡D) or low beam LO (≡D) for the headlights.

The dimmer switch will not change the assist headlight beam.

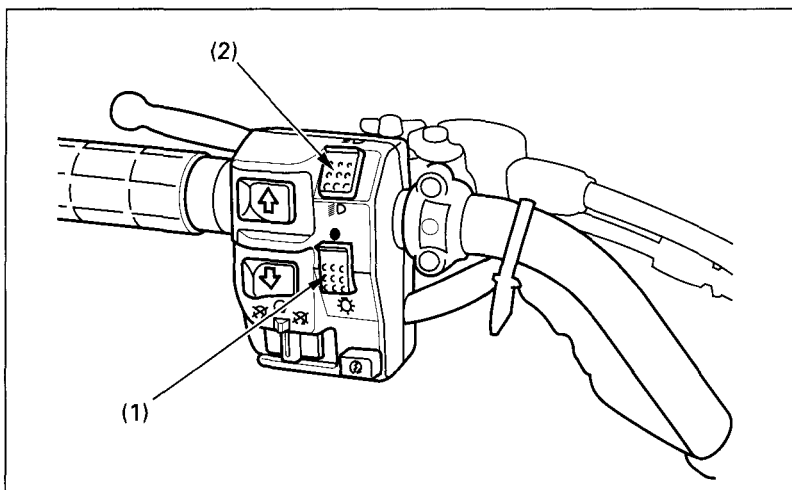

Fig. 2-13 (1) Headlight switch

(2) Dimmer switch