

TRANSPORTING YOUR FOURTRAX

When you transport your FOURTRAX, we recommend that you carry the vehicle in its normal operating position (on all four wheels) and follow these procedures:

1. Set the parking brake and place the transmission in gear.
2. Turn the fuel valve OFF.
3. Secure the vehicle with "tie downs" in the areas shown (Fig. 4-41). Suitable "tie downs" are available from your Honda dealer. Ordinary rope is not recommended because it can stretch under load.

CAUTION:

Using tie downs in any other areas can damage your FOURTRAX.

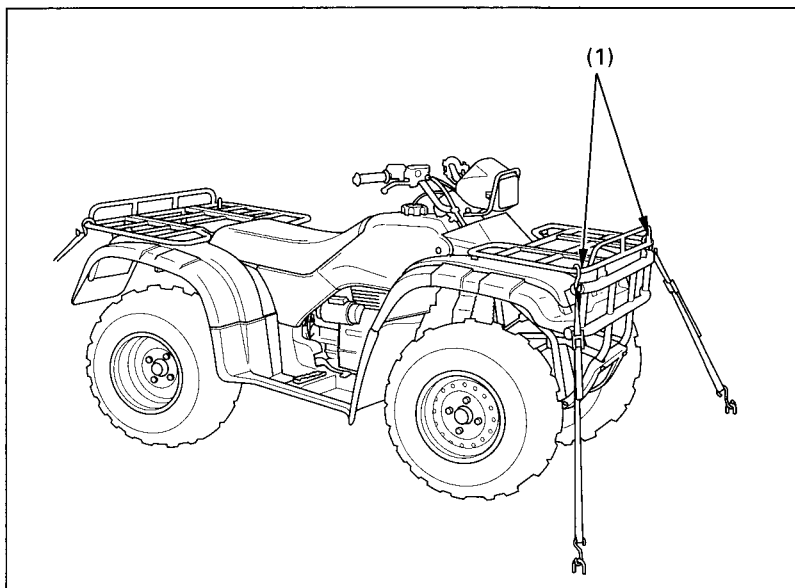

Fig. 4-41 Points to secure FOURTRAX with tie downs

(1) Front cargo rack