

SPARK ARRESTER

The exhaust system must be periodically purged of accumulated carbon.

Regular servicing prevents carbon buildup (which can diminish engine performance) and also complies with USDA regulations for regular maintenance to assure proper function. The spark arrester prevents random sparks from the combustion process in your engine from reaching the environment.

The use of safety glasses is recommended for this procedure.

Because of the possible fire hazard, check that there are no combustible materials in the area before purging the spark arrester.

To purge the system:

1. Select a well-ventilated area free of combustible materials and make sure the exhaust pipe is cool.
2. Remove the bolt. (Fig. 4-38)
3. Start the engine and rev it up approximately twenty times while momentarily creating exhaust system back pressure by blocking the end of the muffler with a shop towel.
4. Stop the engine and allow the exhaust pipe to cool.
5. Reinstall the bolt securely.

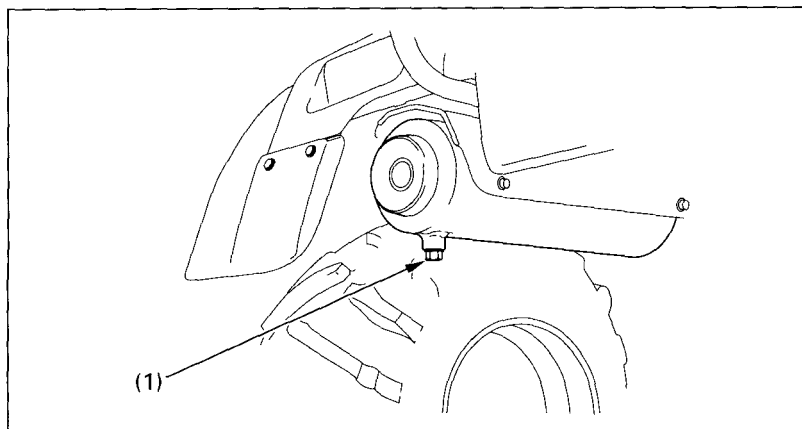

Fig. 4-38

(1) Bolt