

## Storage Compartment

The storage compartment (1) (Fig. 2-25) is below the rear cargo rack (2). To open the compartment, unhook the rubber strap (3). The owner's manual (4), tool kit (5), and air pressure gauge (6) should be stored in the storage compartment (1).

Be careful not to flood this area when washing your FOURTRAX or riding through water.

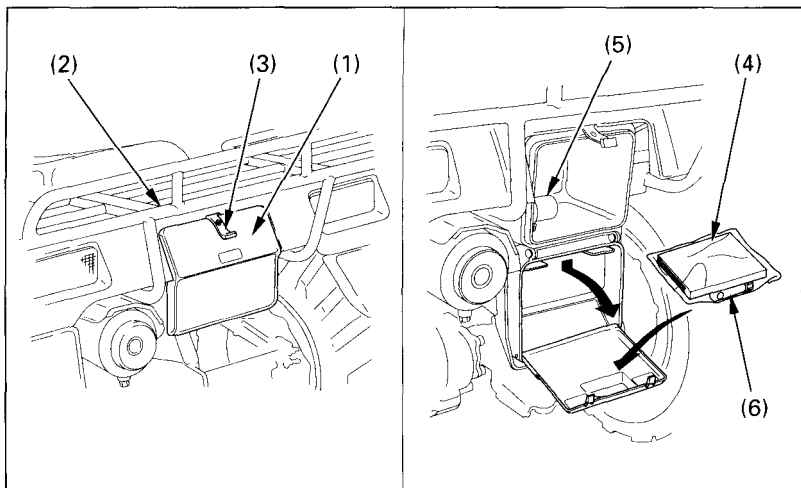

Fig. 2-25 (1) Storage compartment  
(2) Rear cargo rack  
(3) Rubber strap

(4) Owner's manual  
(5) Tool kit  
(6) Air pressure gauge