

THROTTLE

Throttle Cable and Lever

Check the condition of the throttle cable and the operation of the throttle lever. Make sure the cable does not bind or interfere with smooth operation of the throttle in any steering position. If the cable is worn or kinked, have it replaced by your Honda dealer.

Throttle Free Play

Throttle free play, measured at the tip of the throttle lever (Fig. 4-3), should be:

3–8 mm (0.1–0.3 in)

To adjust throttle free play:

1. Slide the rubber sleeve (1) back to expose the throttle cable adjuster (2).
2. Loosen the lock nut (3), then turn the adjuster to obtain the correct free play.
3. Tighten the lock nut and reinstall the sleeve.

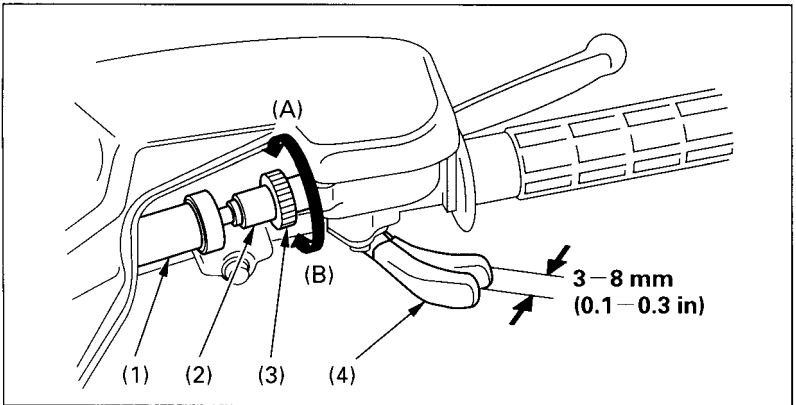

Fig. 4-3 (1) Rubber sleeve (2) Cable adjuster (3) Lock nut (4) Throttle lever (A) To decrease free play (B) To increase free play

Other Checks

Check the throttle cable for kinks and signs of wear that could cause stretching or failure. Lubricate the throttle cable with a commercially available lubricant to prevent premature wear and corrosion.