

Reverse Selector Knob

The reverse selector knob (Fig. 2-17) (1) is on the rear brake lever.

To shift into reverse, first bring the FOURTRAX to a complete stop and make sure the transmission is in neutral. While pushing the reverse selector knob (1) in, squeeze the rear brake lever (2), then depress the gearshift pedal.

CAUTION:

Bring the FOURTRAX to a complete stop before shifting the transmission into reverse. If the transmission is shifted into reverse while the vehicle is moving, the transmission will be damaged.

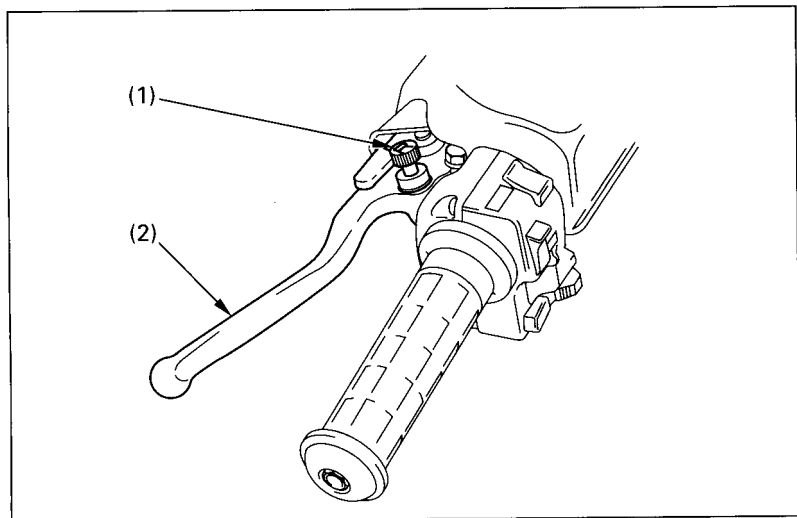

Fig. 2-17 (1) Reverse selector knob (2) Rear brake lever