

Changing the Engine Oil and Oil Filter

Engine oil should be changed in accordance with the Maintenance Schedule. Use motor oils of the grade and viscosity recommended.

When changing oil, drain the oil from the crankcase while the engine is still warm. This will ensure complete and rapid draining.

To change the oil and oil filter:

1. With the FOURTRAX on level ground, remove the oil filler cap (1) from left side of the crankcase (Fig. 4-12).
2. Place an oil drain pan under the crankcase and remove the oil drain plug (2).

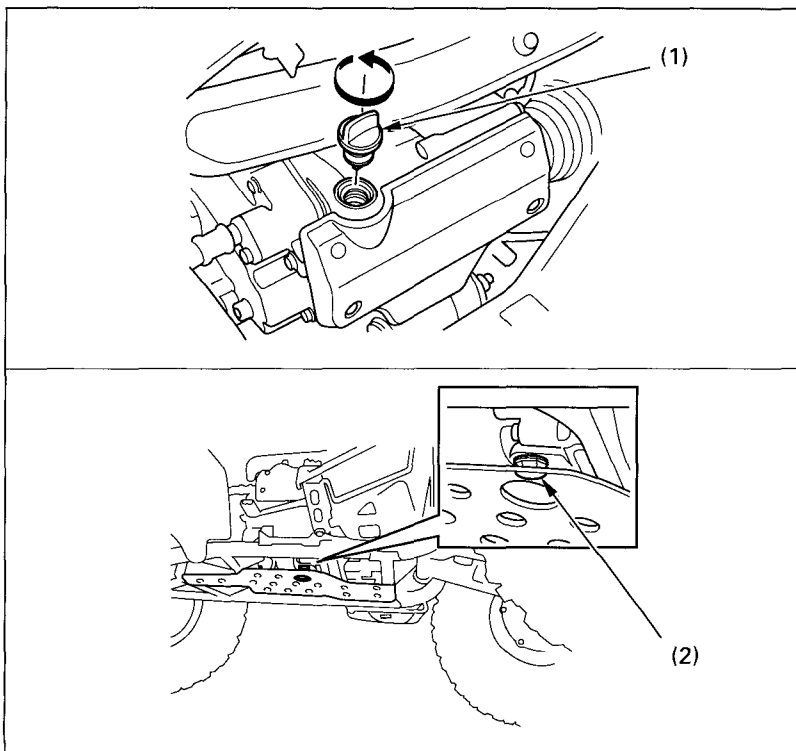

Fig. 4-12

(1) Oil filler cap
(2) Oil drain plug