

Fuel Fill Cap

After refueling, be sure to tighten the fuel fill cap (Fig. 2-25) until it clicks.

Insert the breather tube (2) into the handlebar cover hole (3).

To refuel refer to page 94 .

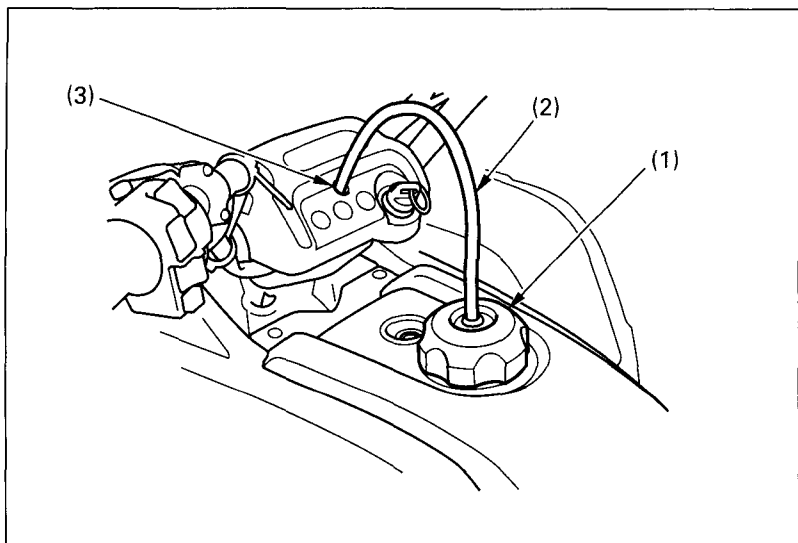

Fig. 2-25 (1) Fuel fill cap

(2) Breather tube

(3) Handlebar cover hole