

## ENGINE GUARD AND SKID PLATES

The engine guard (Fig. 4-39) protects the engine crankcase. The skid plates (2) protect the frame and rear final gear case. Check the guard and plates for cracks, damage or looseness at intervals shown in the Maintenance Schedule (page 96–97). Replace the guard and plates with new ones if they are cracked or damaged. If the guard and plate bolts are loose, tighten them securely.

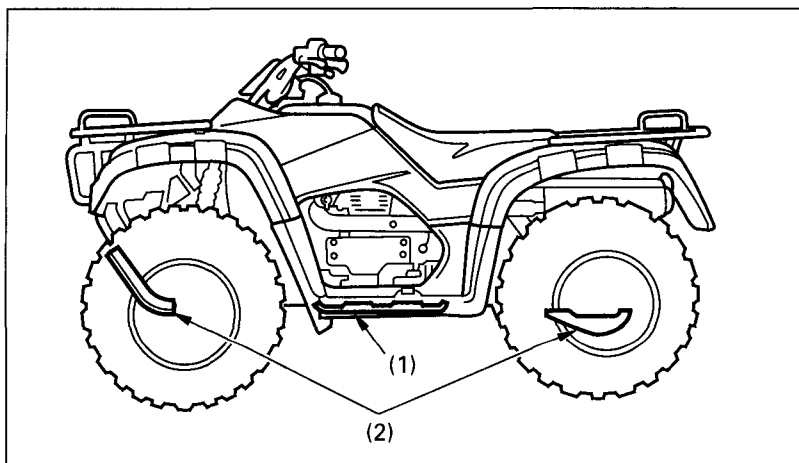

Fig. 4-39 (1) Engine guard

(2) Skid plates