

CAUTION:

The spark plug must be securely tightened. An improperly tightened plug can become very hot and possibly damage the engine.

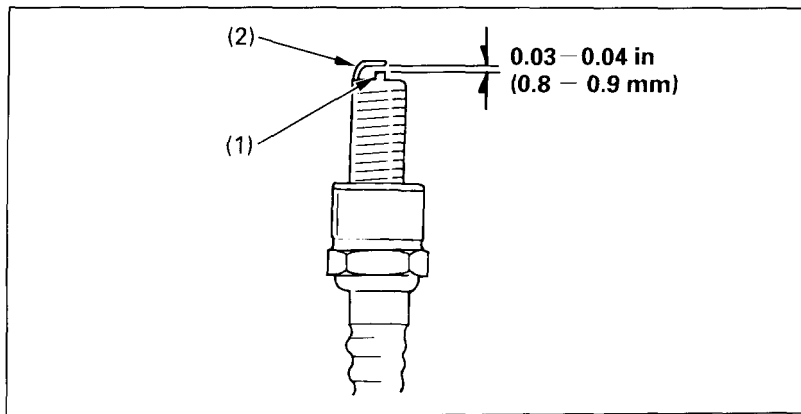

Fig. 4-16 (1) Center electrode (2) Side electrode

VALVES

Valve clearance should be:
0.006 in (0.15 mm)

Excessive clearance will cause noise. Insufficient clearance will cause loss of power and possibly damage the valves.

For those who are mechanically proficient and have the proper tools, instructions on adjusting valve clearances are given in the official Honda Service Manual. All others should have valves adjusted by an authorized Honda dealer.