

LIGHTS

Headlight and Dimmer Switches

The headlight and dimmer switches (Fig. 2-17) are above the engine stop switch, next to the left handgrip.

Turning the headlight switch (1) ON turns the headlights on. Use the dimmer switch (2) to select either high beam (HI) or low beam (LO).

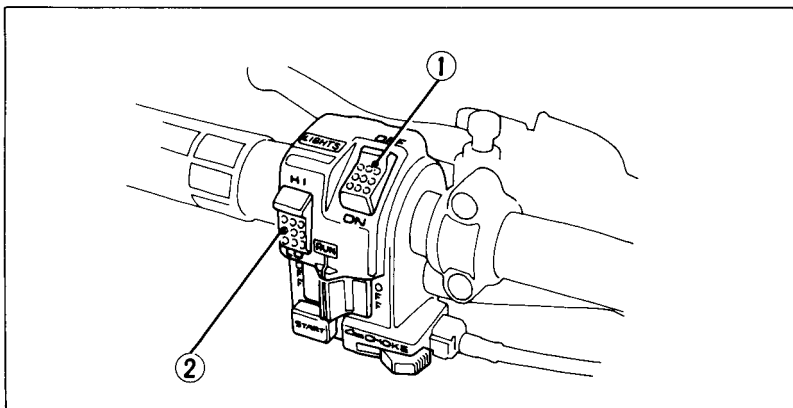

Fig. 2-17 (1) Headlight switch (2) Dimmer switch

Engine Oil Temperature Warning Lamp

If the engine oil gets too hot, the engine oil temperature warning lamp (Fig. 2-18) will light.

NOTE:

The oil temperature warning lamp should come on when the ignition switch is turned ON. This is not a problem. The light should go off a few seconds after the engine is started.

CAUTION:

If the light does not come on with ignition switch ON: check the bulb and replace it if it is burned out.

Contact your authorized Honda dealer for assistance if you cannot correct the problem.