

Kick Starter

The kick starter (Fig. 2-11) is on the right side of the FOURTRAX. It is used to start the engine when the battery is low. To operate the kick starter:

1. Unsnap and remove the right side cover (2).
2. Rotate the kick starter (1) outward.

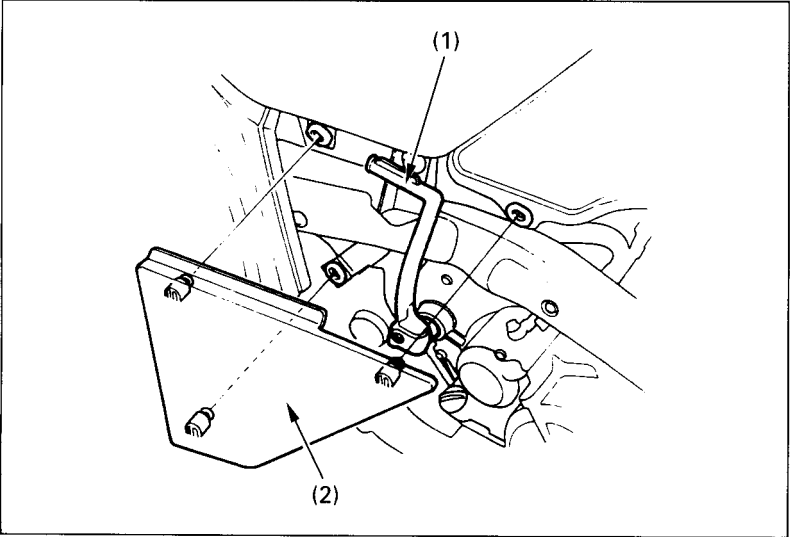

Fig. 2-11 (1) Kickstarter

(2) Right side cover