

LIGHTS

Headlight and Dimmer Switches

The headlight and dimmer switches (Fig. 2-9) are above the engine stop switch, next to the left handgrip.

Turning the headlight switch (1) ON (☀) turns the headlight on. Use the dimmer switch (2) to select either high beam HI (≡D) or low beam LO (≡D).

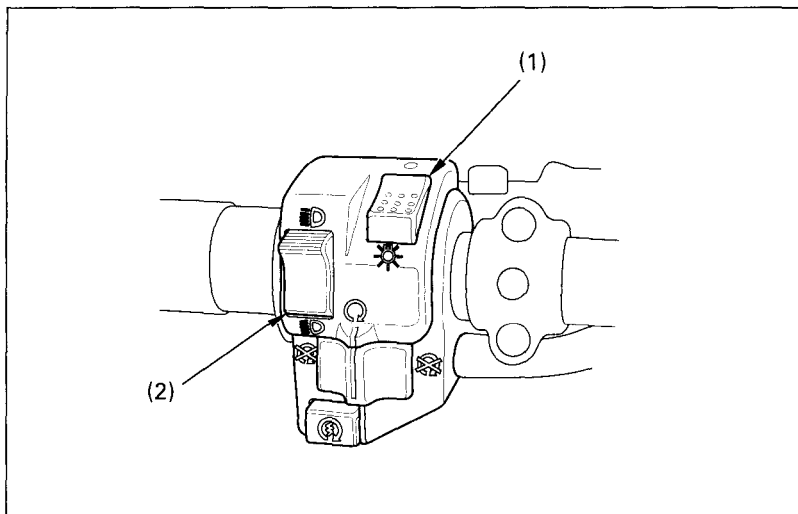

Fig. 2-9

(1) Headlight switch

(2) Dimmer switch