

### Storage Compartment

The storage compartment (Fig. 2-21) is below the rear cargo rack. To open the compartment, unhook the rubber strap (2). The tool kit (3) should be stored in the storage compartment.

Be careful not to flood this area when washing your FOURTRAX or riding through water.

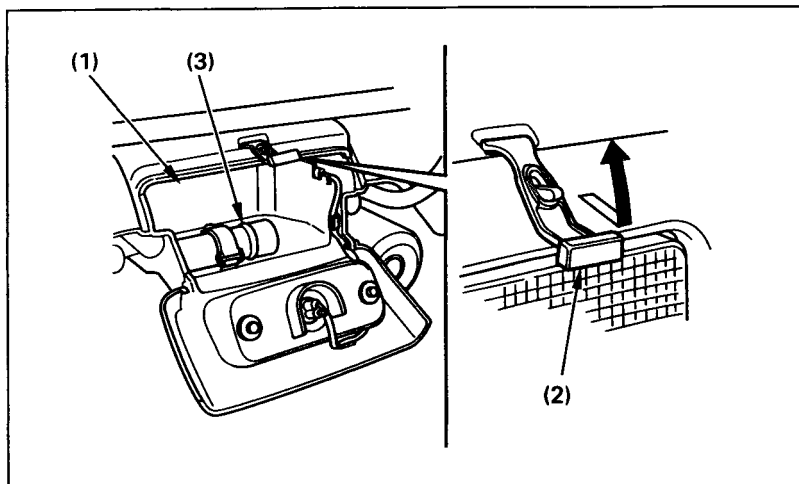

Fig. 2-21 (1) Storage compartment  
(2) Rubber strap

(3) Tool kit