

STOPLIGHT SWITCH ADJUSTMENT

Refer to the Safety Precautions on page 75 .

Check the operation of the stoplight switch (1) at the right side behind the engine from time to time.

Adjustment is done by turning the adjusting nut (2). Turn the nut in the direction (A) if the switch operates too late and in direction (B) if the switch operates too soon.

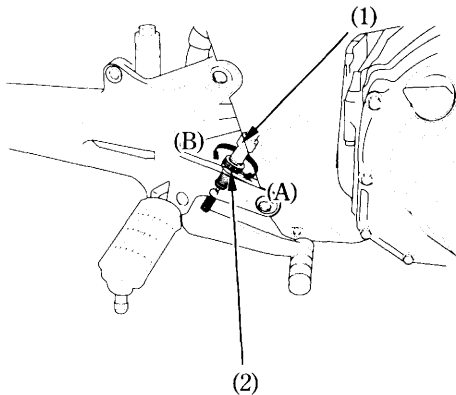

- (1) Stoplight switch
- (2) Adjusting nut